

RACS 5 System Kontroli Dostępu

Tablica Demonstracyjna DB-6A

roger[®]

Intelligence for Building

MCT12M-IO
Czytnik zbliżeniowy z klawiaturą i wbudowanymi liniami we/wy

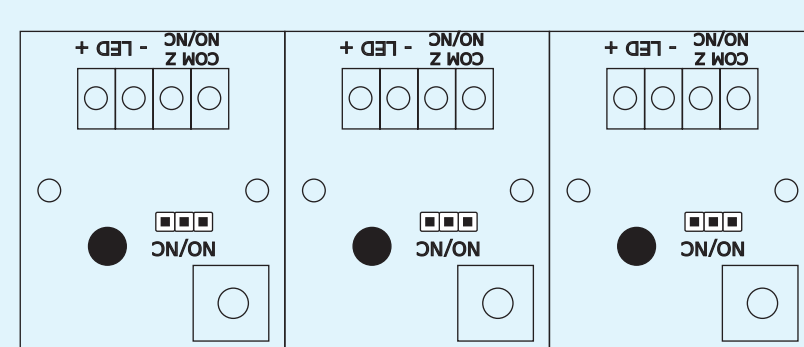
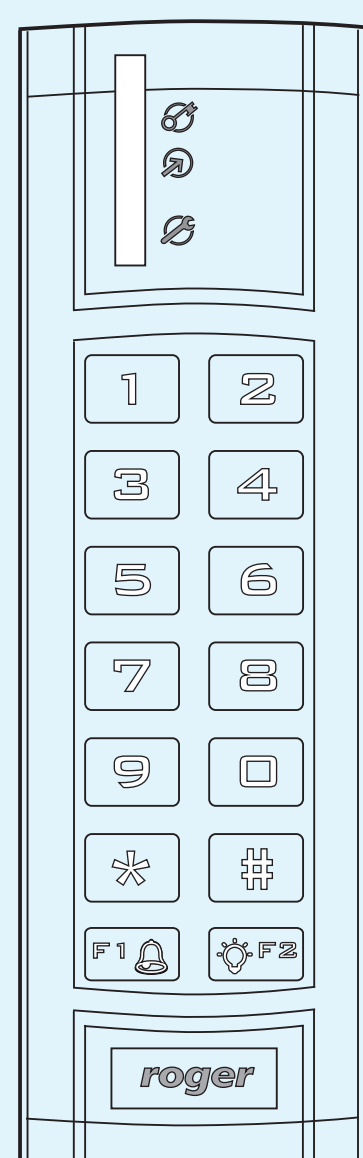

IN1/OUT1 IN2/OUT2 IN3/REL1

MCT12M
Czytnik zbliżeniowy z klawiaturą

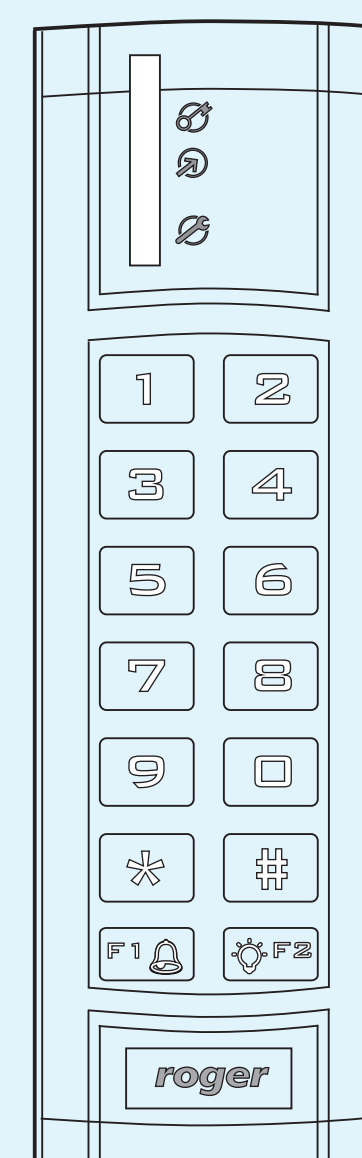

MCT82M-IO
Czytnik zbliżeniowy z klawiaturą i wbudowanymi liniami we/wy

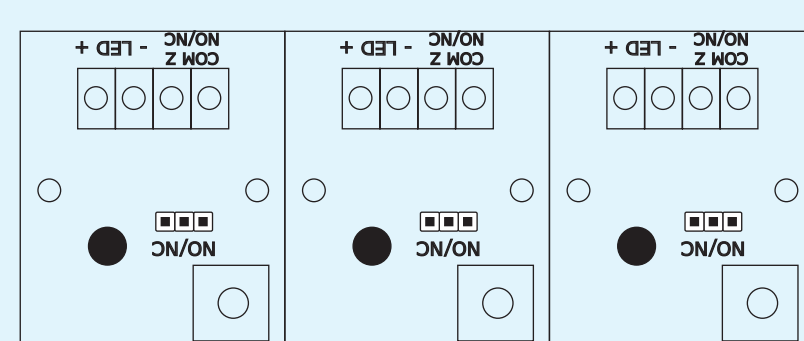

IN1/OUT1 IN2/OUT2 IN3/REL1

MCT82M
Czytnik zbliżeniowy z klawiaturą



MCT84M
Czytnik zbliżeniowy z klawiaturą

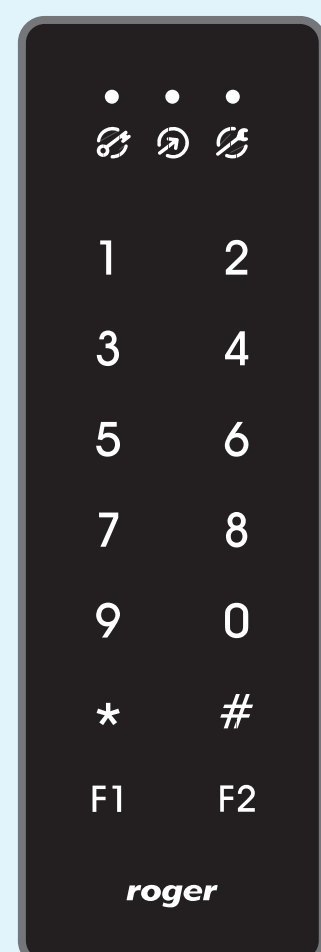

MCT84M
Czytnik zbliżeniowy z klawiaturą

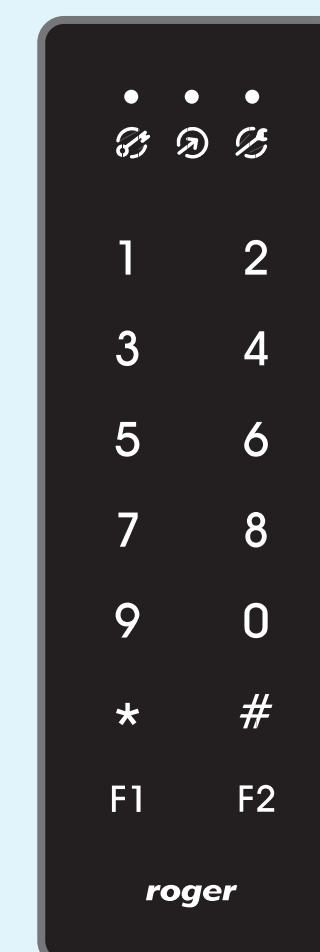

MCX8
Ekspander we/wy

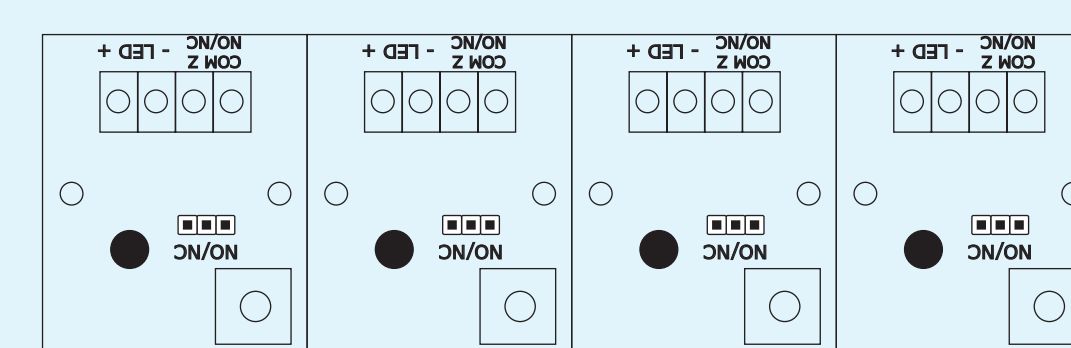
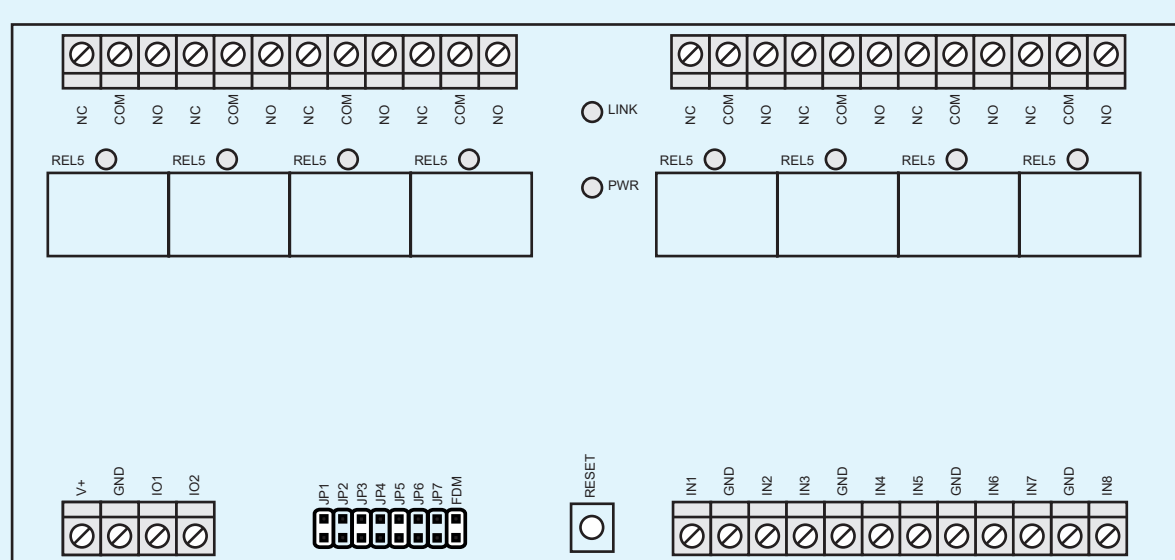

IN1/REL1 IN2/REL2 IN3/REL3 IN4/REL4

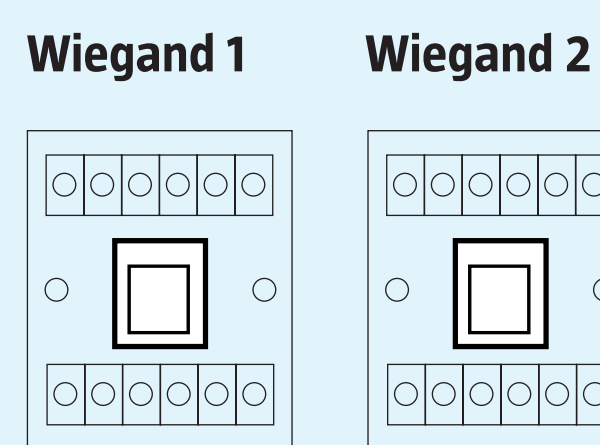

RS485 A

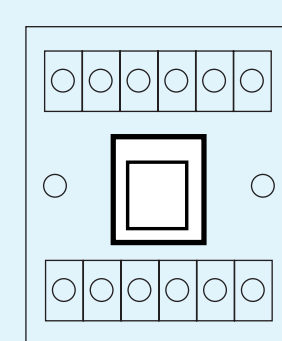

MC16
Kontroler dostępu

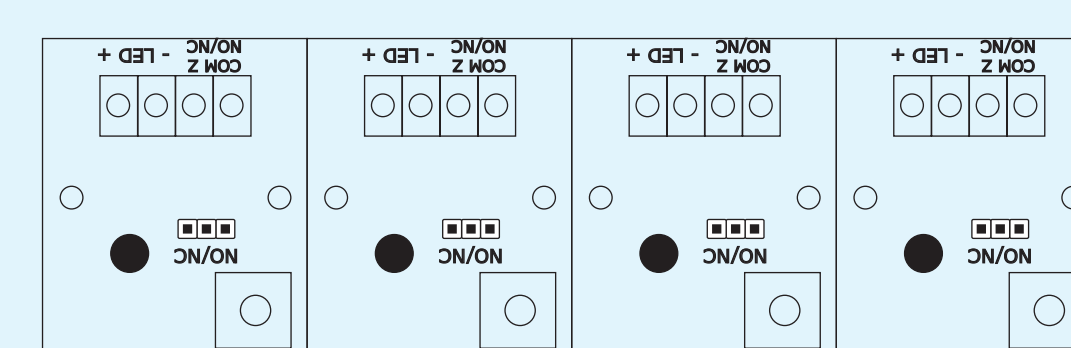
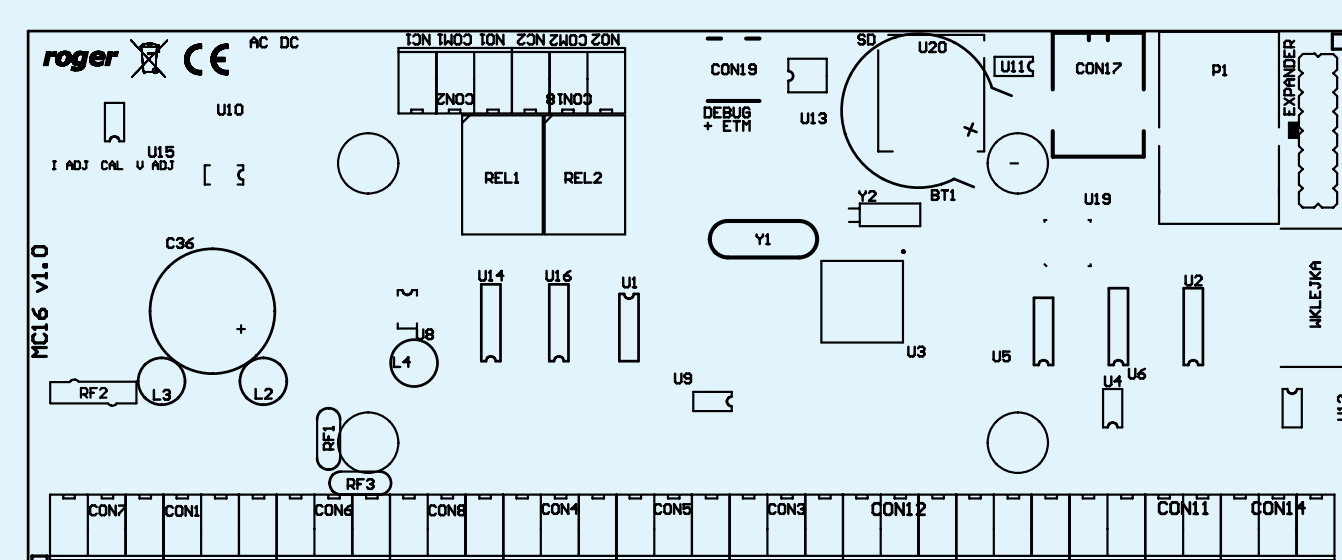

IN5/OUT5 IN6/OUT6 IN7/REL1 IN8/REL2

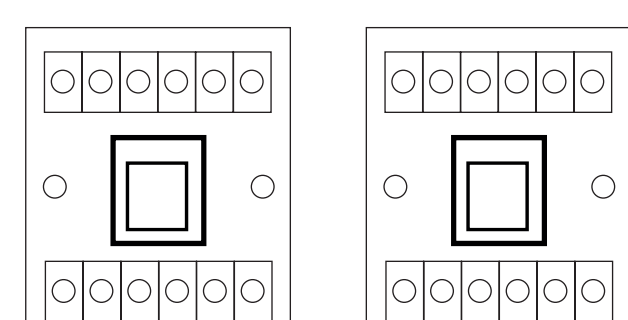

RS485 B

RACS CLK/DTA

RUD-1 Interfejs komunikacyjny USB-RS485

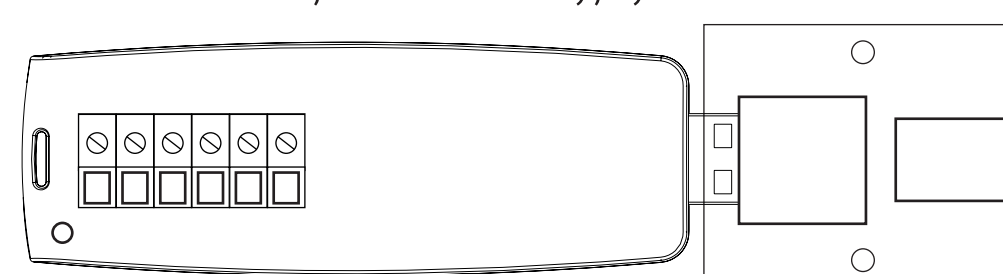

RUD-3 Czytnik kart 13.56 MHz MIFARE

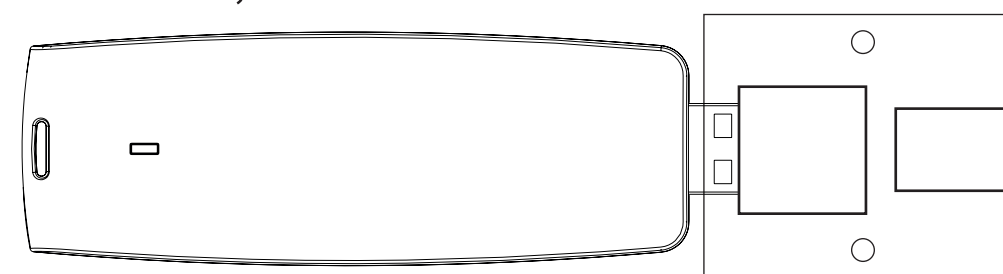

Legenda

- Magistrala RS485 —
- Połączenia linii we/wy —
- Magistrala RACS CLK/DTA —

ROGER sp. z o.o. sp. k.
Gościszewo 59
82-400 Sztum
T. +48 55 272 0132
E. roger@roger.pl
www.roger.pl

